

PRZEKRÓJ M-M  
SKALA 1 : 10

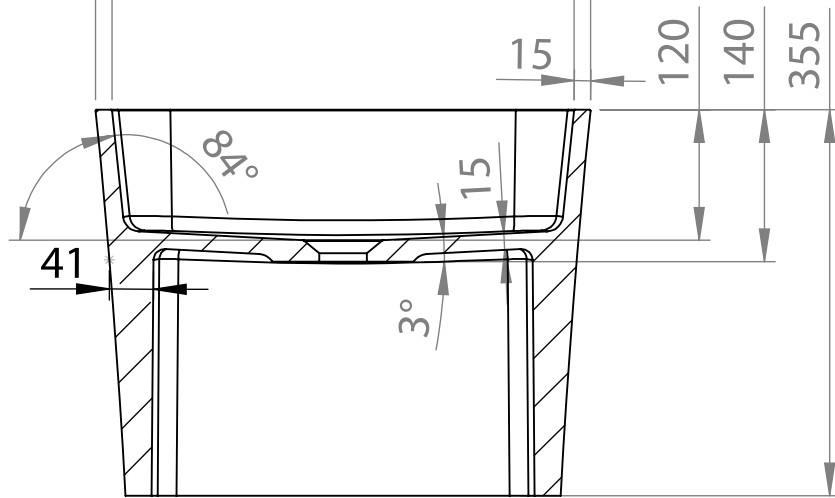

PRZEKRÓJ N-N  
SKALA 1 : 10

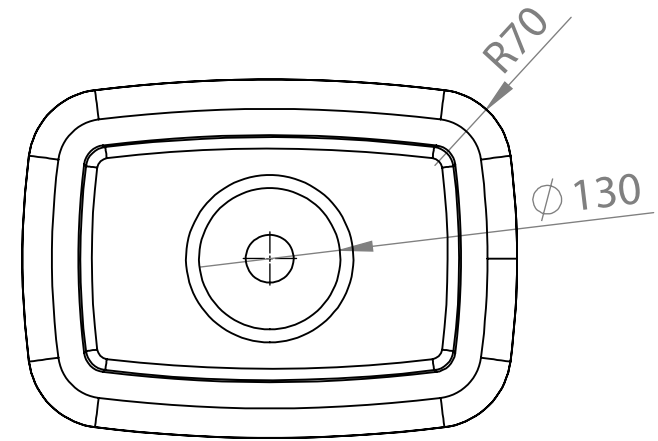